

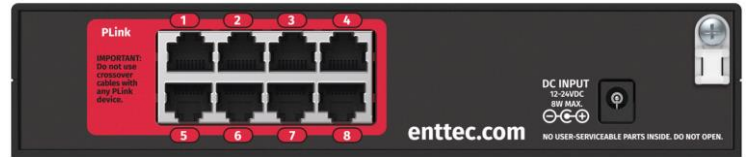

PIXELATOR MINI – Datasheet

16 Universe (8 output) master controller for a PLINK system.



Contents

| | |
|---|---|
| Safety | 2 |
| Electrical safety | 2 |
| System Planning and Specification | 2 |
| Protection from Injury During Installation..... | 2 |
| Installation Safety Guidelines..... | 3 |
| Wiring diagrams | 3 |
| Functional features | 3 |
| PLINK INJECTORS | 3 |
| LED status indicator | 4 |
| Out of the Box | 4 |
| Networking..... | 4 |
| Web Interface | 4 |
| Home..... | 5 |
| Settings / Firmware Update..... | 5 |
| Network Stats | 6 |
| Update Firmware | 6 |
| Servicing, Inspection & Maintenance..... | 7 |
| Cleaning..... | 7 |
| Package content..... | 7 |
| Ordering information | 7 |

Safety

 Ensure you are familiarized with all key information within this guide, datasheet and other relevant ENTTEC documentation before specifying, installing, or operating an ENTTEC device. If you are in any doubt about system safety, or you plan to install ENTTEC device in a configuration that is not covered within this guide, contact ENTTEC or your ENTTEC supplier for assistance.

ENTTEC's return to base warranty for this product does not cover damage caused by inappropriate use, application, or modification to the product.

Electrical safety

- 
- This product must be installed in accordance with applicable national and local electrical and construction codes by a person familiar with the construction and operation of the product and the hazards involved. Failure to comply with the following installation instructions may result in death or serious injury.
 - Do not exceed the ratings and limitations defined in the product datasheet or this document. Exceeding can cause damage to the device, risk of fire and electrical faults.
 - Ensure that no part of the installation is or can be connected to power until all connections and work is complete.
 - Before applying power to your installation, ensure your installation follows the guidance within this document. Including checking that all power distribution equipment and cables are in perfect condition and rated for the current requirements of all connected devices and factor in overhead and verify that it is appropriately fused and voltage is compatible.
 - Remove power from your installation immediately if accessories power cables or connectors is in any way damaged, defective, shows signs of overheating or are wet.
 - Provide a means of locking out power to your installation for system servicing, cleaning and maintenance. Remove power from this product when it is not in use.
 - Ensure your installation is protected from short circuits and overcurrent. Loose wires around this device whilst in operation, this could result in short circuiting.
 - Do not over stretch cabling to the device's connectors and ensure that cabling does not exert force on the PCB.
 - Do not 'hot swap' or 'hot plug' power to the device or its accessories.
 - Do not connect any of this device's V- (GND) connectors to earth.
 - Do not connect this device to a dimmer pack or mains electricity.
 - Label any PLINK output Cat5/6 connector and DO NOT connect to non-PLINK device (eg Ethernet Switch). Connecting unlike systems could result in serious damage to equipment.

System Planning and Specification

- 
- To contribute to an optimal operating temperature, where possible keep this device out of direct sunlight.
 - The maximum recommended cable distance between the Pixelator Mini's output and Plink Injector is 300m (1000ft). ENTTEC advises against running cabling close to sources of electromagnetic interference (EMF) i.e., mains power cabling / air conditioning units.
 - This device has an IP20 rating and is not designed to be exposed to moisture or condensing humidity.
 - Ensure this device is operated within the specified ranges within its product datasheet.

Protection from Injury During Installation

- 
- Installation of this product must be performed by qualified personnel. If ever unsure always consult a professional.
 - Always work with a plan of the installation that respects all system limitations as defined within this guide and product datasheet.
 - Keep product and its accessories in its protective packaging until final installation.
 - Note the serial number of each product and add it to your layout plan for future reference when servicing.
 - All network cabling should be terminated with an RJ45 connector in accordance with the T-568B standard.
 - Always use suitable personal protective equipment when installing ENTTEC products.
 - Once installation is completed, check that all hardware and components are securely in place and fastened to supporting structures if applicable.

Installation Safety Guidelines



- The device is convection cooled, ensure it receives sufficient airflow so heat can be dissipated.
- Do not cover the device with insulating material of any kind.
- Do not operate the device if the ambient temperature exceeds that stated in the device specifications.
- Do not cover or enclose the device without a suitable and proven method of dissipating heat.
- Do not install the device in damp or wet environments.
- Do not modify the device hardware in any way.
- Do not use the device if you see any signs of damage.
- Do not handle the device in an energized state.
- Do not crush or clamp the device during installation.
- Do not sign off a system without ensuring all cabling to the device and accessories has been appropriately restrained, secured and is not under tension.

Wiring diagrams

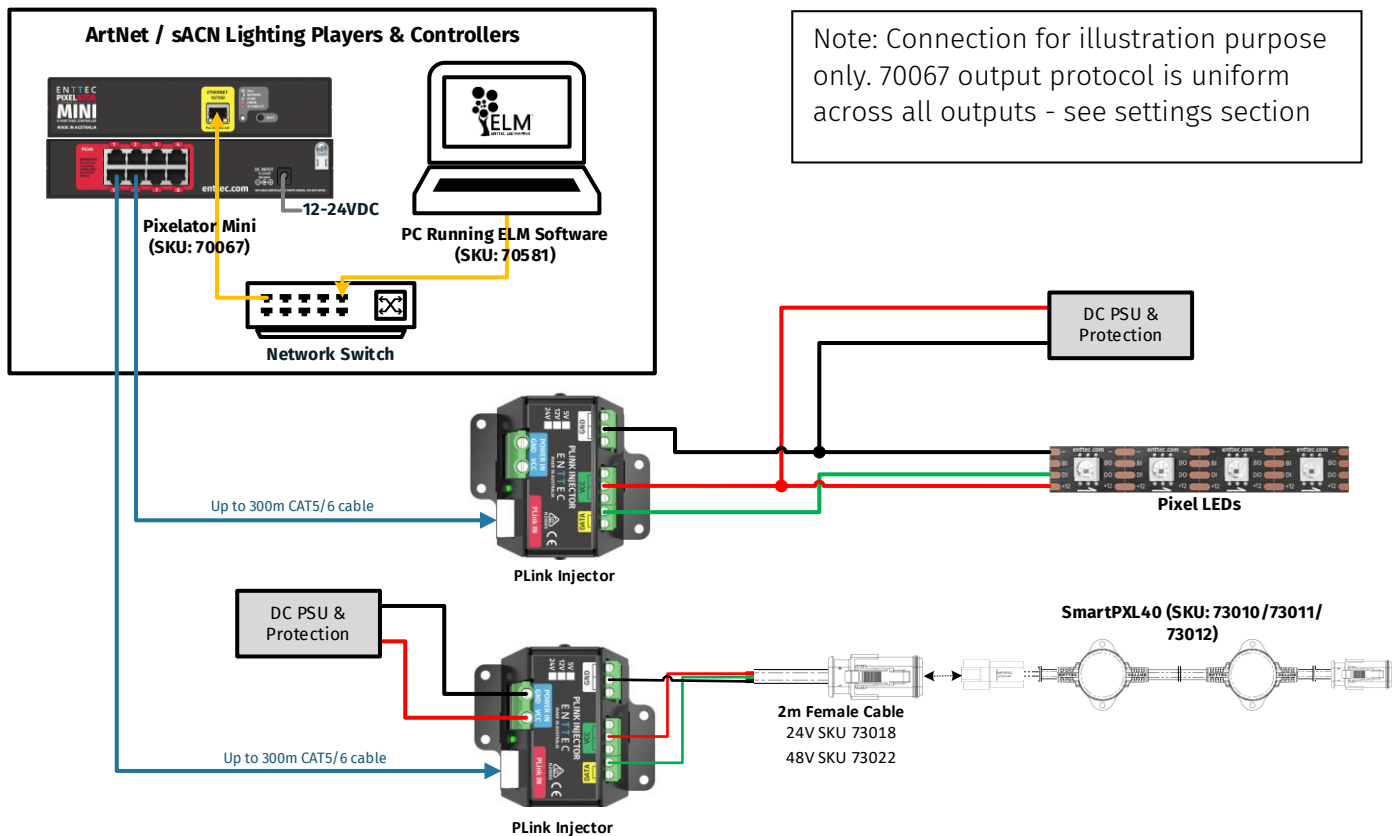

Functional features

PLINK INJECTORS (Sold separately)

From one of the PIXELATOR MINI's PLINK Data outputs, you can run up to 300m of Cat6 cable to a single PLINK INJECTOR. Since all data conversion is processed on the PIXELATOR MINI, the PLINK INJECTOR is kept as compact as possible. At the PLINK INJECTOR, you can wire up an external DC power supply. The PLINK has the capability to handle 10amps through the device. It is important that your power supplies voltage matches the voltage of your Pixels, as well as having a PLINK which is compatible with the voltage range:

- SKU 73546 is designed for Pixels with a 5VDC input,
- SKU 73544 is designed for Pixels with a 12-24VDC input.

Each PLINK INJECTOR can then be wired up to 3m (total cable length) away from the first Pixel. The PLINK INJECTOR can drive up to 340 RGB individual pixels (2 DMX universes).

The PIXELATOR MINI can control a range of SPI (Pixel) protocols, a full list can be found on our website.

PLINK Data: The PIXELATOR MINI converts Art-Net, saCN into our own PLINK data where it is converted to the SPI (Pixel) protocol by Plink Injector.

PLINK Data Pinout: PLINK Data is sent over Cat5/6 cable over 3 pins within a RJ45 connector. These pins are:

| | | |
|--|-----------------|-------------------|
| ■ Pin 1: Data + | ■ Pin 2: Data - | ■ Pin 7/8: Ground |
| <i>Do not use crossover cables with any Plink device</i> | | |

LED status indicator

The PIXELATOR MINI comes with one RGB status LED and 2 LED on RJ45 port (Link & Activity).

| Colour | Status |
|-------------------|---|
| White | Idle. |
| Green (blinking) | Pixel Link Data is being output. |
| Red (blinking) | Error State. Requires a firmware update or needs to be rebooted. A reset might be required if it stays in error-mode on reboot. |
| Purple (blinking) | IP Address Conflict. Please change the IP address manually or enable DHCP. |

Out of the Box

As default, the PIXELATOR MINI will output first 16 Universes of Art-Net starting at universe 0 (0x00), with two Universes per port.

The PIXELATOR MINI will be set to a DHCP IP address as default. If the DHCP server is slow to respond, or your network does not have a DHCP server, the PIXELATOR MINI will fall back to the default Static IP address which will be printed on the PIXELATOR MINI's packaging, but also can be calculated from the last three bytes (pairs) of the Serial Number, converting the Hex (bytes) into Decimal values. The IP address will read as 10.(byte1).(byte2).(byte3). For example, if your Serial Number is 0050C082356 the last three bytes (pairs) are FF, FF and 55, when converting these Hex values to Decimal Values the conversion makes default static IP: 10.8.17.38.

| N/A | 08 | 23 | 56 |
|-----|----|----|----|
| 10 | 8 | 17 | 38 |

Networking

PIXELATOR MINI can be configured to be either DHCP or Static IP address.

DHCP: On power up and with DHCP enabled, if the PIXELATOR MINI is on a network with a device/router with a DHCP server, the PIXELATOR MINI will request an IP address from the server. If the DHCP server is slow to respond, or your network does not have a DHCP server, the PIXELATOR MINI will fall back to the Static IP address. If a DHCP address is provided, this can be used to communicate with the PIXELATOR MINI.

Static IP: By default (out of the box) the Static IP address will be unique based on the devices Serial Number (See out of the box section for details). If the PIXELATOR MINI has DHCP disabled or if the PIXELATOR MINI falls back to the Static IP address after being unable to find a DHCP server, the Static IP address given to the device will become the IP address to communicate with the PIXELATOR MINI. The fall-back address will change from the default once it is modified in the web interface.

Web Interface

Configuring PIXELATOR MINI is done through a web interface which can be brought up on any modern web browser.

- A Chromium based browser (i.e. Google Chrome) is recommended for accessing the PIXELATOR MINI web interface.
- As the PIXELATOR MINI is hosting a web server on the local network and does not feature an SSL Certificate (used to secure online content), the web browser will display the 'Not secure' warning, this is to be expected.

Identified IP address: If you are aware of the PIXELATOR MINI's IP address (either DHCP or Static), then the address can be typed directly into the web browsers URL field.

Unidentified IP address: If you are not aware of the PIXELATOR MINI's IP address (either DHCP or Static) the following discovery methods can be used on a local network to discover devices:

- An IP scanning software application (i.e. Angry IP Scanner) can be run on the local network to return a list of active devices on a local network.
- Devices can be discovered using Art Poll (i.e. DMX Workshop if set to use ArtNet).
- The device Default IP address will be printed on the physical label on the rear of the product.

- ENTTEC free NMU (Node Management Utility) software for Windows and MacOS (support up to Mac OSX 10.11), which will Discover ENTTEC devices on the Local Area Network, displaying their IP addresses before opting to Configure the device, opening the Web Interface.



Note: The eDMX protocols, the controller and the device using to configure PIXELATOR MINI must be on the same Local Area Network (LAN) and be within the same IP address range as the PIXELATOR MINI. For example, if your PIXELATOR MINI is on Static IP address 10.8.17.38, then your computer should be set to something such as 10.8.17.20. It is also recommended that all devices Subnet Mask are the same across your network.

Home

The landing page for the PIXELATOR MINI web interface is the Home tab. This tab is designed to give you a read-only device overview.

This will display:

- Node Name
- Firmware Version
- Serial Number
- DHCP Status
- IP Address
- NetMask
- Mac Address
- Link Speed
- Input
- Output

Settings

The PIXELATOR MINI's settings can be configured within the Settings tab.

- Node Name:** The name of PIXELATOR MINI will be discoverable within Poll replies.
- DHCP:** Enabled by default. When enabled, the DHCP server on the network is expected to automatically provide the IP address to the PIXELATOR MINI. If no DHCP router/server is present or DHCP is disabled, the PIXELATOR MINI will fall back to the static IP address.
- IP Address / NetMask:** These are used if DHCP is disabled or unavailable. These options set the Static IP address. These settings should be set to be compatible with other devices on the network.
- DMX Protocol Input:** Choose between Art-Net, sACN, ESP and Kling-net as the Protocol.
- LED Protocol Output:** Select the SPI protocol which matches the Pixels that the PIXELATOR MINI will control.
- Universe/Output:** Select how many Universes each output should control (0-2: 0 will display the output).
- First Universe:** Allow selections of the first universe that the output will be mapped to.
- Second Universe:** Allow selections of the second universe that the output will be mapped to.
- Pixel Order:** The rate at which PIXELATOR MINI will output the Data from its DMX port (40 Frames per second is default). It will repeat the last received frame to comply with DMX standard.
- Pixel Group:** Pixel grouping allows one DMX pixel to drive multiple physical LED pixels. This option is only available when ONE Universe/Output is selected. Defaults to 1.
- DMX Start Add:** Selects DMX slot number for the first pixel to output. This option is only available when ONE universe/Output is selected. Defaults to 0.
- Save:** All changes must be saved to take effect the PIXELATOR MINI takes up-to 10 seconds to save.
- Factory Default:** PIXELATOR MINI will be reset to Factory condition, including the DHCP being enabled, with the original fall-back static IP and with all setting reset (see the Out of the Box section).
- Reboot/Restart:** Please allow up-to 10 seconds for the device to reboot. When the web interface page refreshes the PIXELATOR MINI is ready.

Network Stats

The Network Stats tab is designed to provide an overview of the network data. This is broken down into Ethernet-SPI protocols statistics which can be located within the tabs.

The Summary provides details regarding total packets sent /received, as well as Poll packets, last IP address and Port.

Art-Net Statistics also provide a breakdown of Art-Net DMX packets sent and received. As well as a breakdown of RDM over Art-Net packets including packet sent and received, Subdevice and TOD Control/Request packets.

| Art-Net Statistics | | ESP Statistics | | sACN Statistics | |
|---------------------------|---------|----------------|--|-----------------|--|
| Art-Net Summary | | | | | |
| Poll Packets Received | 0 | | | | |
| Last IP | 0.0.0.0 | | | | |
| Last Port | 0 | | | | |
| Art-Net DMX | | | | | |
| DMX Data Packets Received | 0 | | | | |
| DMX Data Packets Sent | 0 | | | | |

Update Firmware

On selecting the Update Firmware tab, the PIXELATOR MINI normal operation will stop, and the web interface boot into the Update Firmware mode takes up-to 10 seconds.

This mode will display basic information regarding the device including current Firmware Version, Mac Address, Serial Number, and IP address information.

Using the Choose File button, browser your local computer for the latest PIXELATOR MINI firmware file, this will have a .bin extension. The latest firmware can be downloaded from our website.

Next click on the Update Firmware button to begin updating.

After the update has completed, the web interface will load the Home tab, where you can check the update was successful under Firmware Version. Once the Home tab has loaded, the PIXELATOR MINI will resume operation.

| PIXELATOR-MINI - UPDATE FIRMWARE | |
|-----------------------------------|---|
| Current System Information | |
| Boot Version: | ENTTEC Pixelator Mini Boot V1.3 |
| Firmware Version: | ENTTEC Pixelator Mini Firmware V1.12 |
| Mac Address: | 00:50:c2:08:3a:06 |
| Serial No: | c2083a06 |
| Link Speed: | 100 Mbps |
| Current Network Settings | |
| DHCP: | enabled |
| IP Address: | 10.10.10.79 |
| Update Firmware | |
| Select firmware file: | <input type="button" value="Choose File"/> mini_fw_112 bin <input type="button" value="Update Firmware"/> |
| Update progress: | <div style="width: 28%; background-color: green; height: 10px;"></div> 28% |

Reset to factory defaults

Factory resetting the product results in the following:

- Resets device name
- Enables DHCP
- Static IP address reset
- Netmask is set to 255.0.0.0

Using web interface

The reset to defaults command can be found under the Settings tab.

| Updates | |
|-----------------|--|
| Save | <input type="button" value="Save Settings"/> |
| Factory Default | <input type="button" value="Reset to Defaults"/> |
| Reboot/Restart | <input type="button" value="Reboot Now"/> |

Once the command is pressed, a pop-up would appear as shown in the image below:

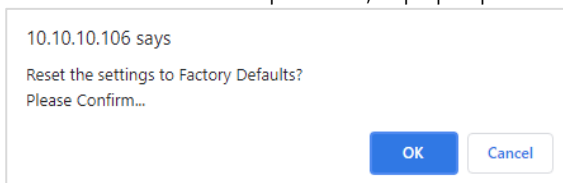



Using the reset button

The reset button restores the network configuration of PIXELATOR MINI to factory defaults:

- To reset to factory defaults, the following procedure must be performed:
- Power off the unit
- Press and hold the Reset button.
- While holding the Reset button, power up the unit, and keep holding the button for 3 seconds.
- Release the Reset button once the status led starts blinking red.
- Power cycle the unit

Servicing, Inspection & Maintenance

-  ■ **The device has no user serviceable parts. If your installation has become damaged, parts should be replaced.**
-  ■ **Power down the device and ensure a method is in place to stop the system from becoming energized during servicing, inspection & maintenance.**

Key areas to examine during inspection:



- Ensure all connectors are mated securely and show no sign of damage or corrosion.
- Ensure all cabling has not obtained physical damage or been crushed.
- Check for dust or dirt build up on the device and schedule cleaning if necessary.
- Dirt or dust buildup can limit the ability for a device to dissipate heat and can lead to damage.

To order replacement devices or accessories contact your reseller or message ENTTEC directly.

Cleaning

Dust and dirt build up can limit the ability for the device to dissipate heat resulting in damage. It's important that the device is cleaned in a schedule fit for the environment it is installed within to ensure maximum product longevity.

Cleaning schedules will vary greatly depending on the operating environment. Generally, the more extreme the environment, the shorter the interval between cleanings.

-  ■ **Before cleaning, power down your system and ensure a method is in place to stop the system from becoming energized until cleaning is complete.**
-  ■ **Do not use abrasive, corrosive, or solvent-based cleaning products on a device.**
-  ■ **Do not spray device or accessories. The device is an IP20 product.**

To clean an ENTTEC device, use low-pressure compressed air to remove dust, dirt, and loose particles. If deemed necessary, wipe the device with a damp microfiber cloth.

A selection of environmental factors that may increase the need for frequent cleaning include:

- Use of stage fog, smoke or atmospheric devices.
- High airflow rates (i.e., in close proximity to air conditioning vents).
- High pollution levels or cigarette smoke.
- Airborne dust (from building work, the natural environment or pyrotechnic effects).

If any of these factors are present, inspect all elements of the system soon after installation to see whether cleaning is necessary, then check again at frequent intervals. This procedure will allow you to determine a reliable cleaning schedule for your installation.

Package content

- PIXELATOR MINI (70067)
- 1 x 2m cat5 cable (79102)
- 1 x 12V PSU adaptor with international plugs
- 2pcs x Rack mounting bracket (79161) + 6pcs x screws
- 2pcs x Surface/Din mounting bracket (79162) +4 pcs x screws
- 2pcs x Din Clip + 4pcs * screws
- 1 x Read Me Card with ELM Promo Code (16 Universes)

Revision update

The Read Me Card with ELM Promo code is implemented on Pixelator Mini (70067) after SN:0050C20845D6 (August 2022).

Ordering information

For further support and browse ENTTEC'S range of products, visit the ENTTEC website

| Item | SKU |
|--------------------------|-------|
| Pixelator Mini | 70067 |
| PLINK INJECTOR (5v) | 73546 |
| PLINK INJECTOR (12v-24v) | 73544 |

enttec.com

MELBOURNE AUS / LONDON UK / RALEIGH-DURHAM USA

Due to constant innovation, information within this document is subject to change.