

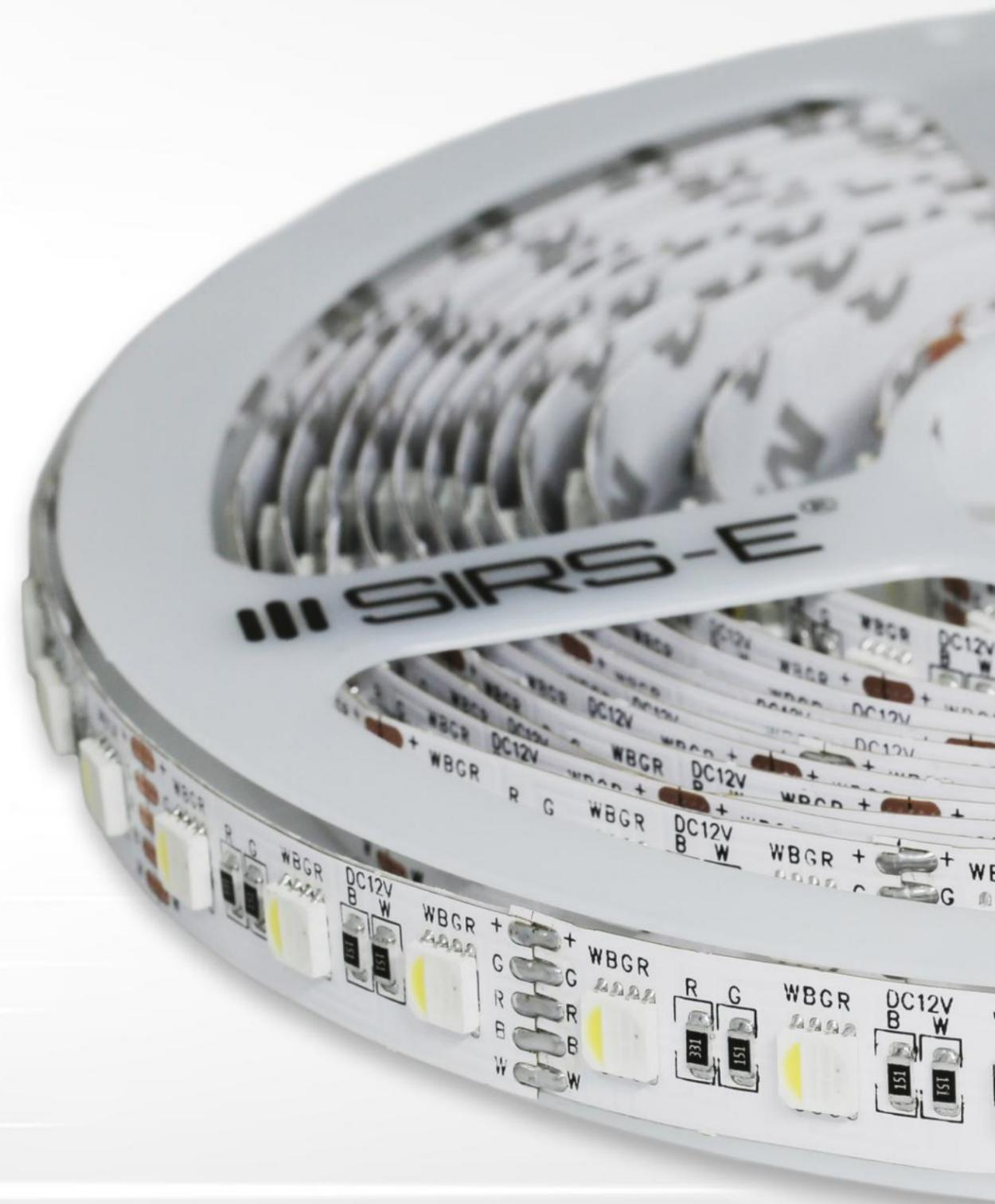

2016 Product Guide





Our company was founded in June of 2005 by a group of young entrepreneurs in McAllen, Texas. As an American-owned company that employs highly qualified professionals, we have more than 50 years of combined experience in LED Lighting and DMX Controls. Not only are we a distributor and dealer of some of the most prestigious brands worldwide, we also employ in-house engineers who take part in privately branded custom hardware, which has allowed us to differentiate our services from that of our competitors.

More than just simple sales and services, we are committed to providing "complete solutions" and a "positive experience" in the areas of supply, consulting, and manufacturing of LED Lighting and DMX Controls. Our knowledgeable and dedicated team is committed to recommending the best products, providing paramount technical guidance and support, and promoting exceedingly competitive prices!

At SIRS Electronics Inc., you will find the highest quality products along with top technical support and the assistance of our experienced engineering team who are standing by to help you. We enjoy supporting ambitious endeavors on a wide range of projects, applications and/or ideas! We assist specifiers, engineers, architects, consultants, installers, and anyone else who may need guidance with a particular project.

Please let us know how we can help you!
The SIRS-E® Team



SIRS-E®, INC.
6101 N 23rd Street
Suite K
McAllen, TX 78504
956.522.2006
www.sirs-e.com
info@sirs-e.com

Table of Contents

General Information

FAQ.....	3
Certifications.....	4

LED Strip Lighting

DMX LED Strip.....	7
AD-PRO-6.....	8
RGBW 4-in-1.....	11
RGB LED Strip.....	15
RGB-DD LED Strip.....	17
White LED Strip.....	21
White-DD LED Strip.....	23
Retrofit Kit	25

LED DMX Controllers

DMX-CON3-C2.....	29
DMX-CON4-C2.....	31
DMX-CON4V2.....	33
DMX-CON6.....	34

Custom Solutions

Custom Projects & Diagrams.....	35
Manufacturing & OEM Services.....	36

1 HOW DO I READ YOUR PRODUCT SKU?

LED Size
5050 stands for the size of the LED chip which is 5.0 x 5.0 mm

Voltage and Color
This indicates whether the LED strip is 5, 12 or 24V and what color the LED chip is.

Density and IP Rating
Density represents how many LEDs are in one meter. The IP rating specifies whether the strip is non-waterproof, waterproof or submersible.

2 WHAT KIND OF COMPONENTS DO I NEED FOR MY LED APPLICATION?

You need 4 basic main components:
1) the LED strip
2) the power supply
3) the controller
4) the wiring, connectors and/or other accessories.

All these options can be found on our website at www.sirs-e.com

You can also contact our Tech Support and Sales Team who are more than happy to help you figure out exactly what you will need for your project.

3 CAN YOU CUSTOMIZE MY ORDER TO FIT MY LED APPLICATION?

Of course! Our Sales and Engineering teams are always ready to design and customize your LED application for you. With an experienced Tech Support team, we can also offer you materials lists, wiring diagrams and answer any questions you may have.

Call us today at 956-522-2006, we are here to help you build your dream project.

FAQ

4 HOW FAST CAN YOU FULLFILL MY ORDER?

Our inventory is always stocked and our shipping department can ship orders the same day if placed before 4pm CT. With shipping carrier options like FedEx Ground, FedEx Express and USPS (for PO Box only), you can be sure that you'll receive your order right when you need it. Returns are inspected by our engineers and processed within 3 days.

5 WHAT IS DMX CONTROL?

DMX stands for Digital Multiplex which is basically a universal digital signal protocol that allows you to control individual colors on LED fixtures.

DMX is represented in universes made up of 512 channels each. i.e. Each RGB LED chip has 3 channels, one for each color. DMX fixtures include Direct DMX LED Strips, LED moving heads, LED bars and LED PARs.



Visit our YouTube Channel for reviews, how-to's, product overviews and much more at:

www.youtube.com/user/LEDlightsDMXcontrols

Certifications



Several of our products, including our line of 12V and 24V LED strips and our DMX controllers, will now carry the UL mark which signifies our compliance with UL safety standards and requirements. UL is a global company with over a century of experience in promoting safe living and working environments. Obtaining an approval from UL indicates that our strips have been verified through validation, testing, inspection, and continuous audit in order to guarantee maximum safety standards and compliance.

So what does this mean for you? The UL mark offers you peace of mind knowing that your home or business is safe with the installation of our products. It ensures that you are receiving the highest quality with absolutely no compromise. Our UL Listing File No. (E479339) can be verified through UL's Online Database.

SIRS-E® is committed to supporting the continuous improvement in the quality of LED products as a replacement for other harmful and inefficient forms of lighting. To prove this commitment, we have opted to partner with LED Lighting Facts which is a program launched by the U.S. Department of Energy.

While UL guarantees the safety of our product, LED Lighting Facts ensures that it meets your expectation for performance. By pledging to reveal the exact performance results acquired from extensive testing by a certified laboratory, you can rest assured that our products will perform precisely as we have stated, allowing you to make a more informed and confident purchase.

You can verify our certification through LED Lighting Facts by visiting their website and searching for SIRS Electronics at the bottom of the page.



DMX

DMX allows users to have pixel by pixel control over their lighting needs and create stunning light shows for a multitude of applications.

Our DMX LED RGB Strip is a dynamically altering effect strip and is compatible with Madrix as well as numerous other DMX control software right out of the box. This strip is built from the same components as our High Quality LED Strip line to ensure maximum durability for any application.

To get the most out of your DMX LED RGB Strips, the AD-PRO-6 is the perfect solution for managing elaborate set-ups. With it, you can control up to 6 universes (3072 DMX Channels) simultaneously, or link up several for potentially unlimited universes.



DMX LED Strip
RGB

Product Details

Compatible with any DMX Software
Cuttable every pixel
Fully dimmable & DMX addressable
Pixel by pixel control
Direct DMX signal to the strip
Can be put inside a recessed channel or extrusion
UV & IR free



Segment Close Up & Dimensions

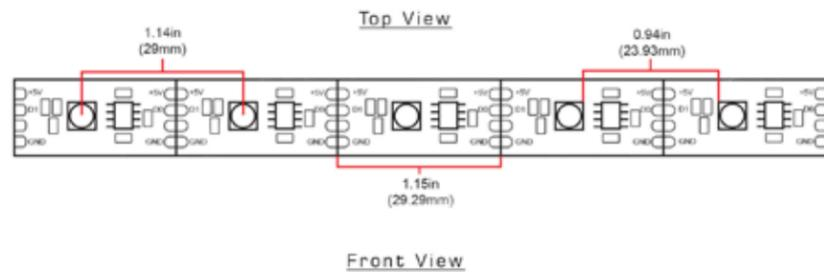

Tech Specs

510 DMX Channels
DMX 512/1990 Protocol
34 LEDs/m
5050 LED Chip (5x5mm)
170 LEDs per reel
16.4ft / 5m reel
5 V DC, 25.7 W, 2494 lm

IP RATINGS

IP67 - Waterproof



Ordering Guide

LED SIZE	DC VOLTAGE	COLOR	LEDs/m	IP
5050	5	RGBD	34	XX
				67
				68



Ethernet DMX 6 Universes
AD-PRO-6

Product Details

Control up to 6 DMX Universes
Ergonomic Enclosure
Built from high quality ABS material
DMX lines have overload protection
Includes all necessary components:
-DC 12V / 1.25A power supply
-Breakout Cable for 6 Universes
-Heavy duty CAT5 RJ45 to RJ45

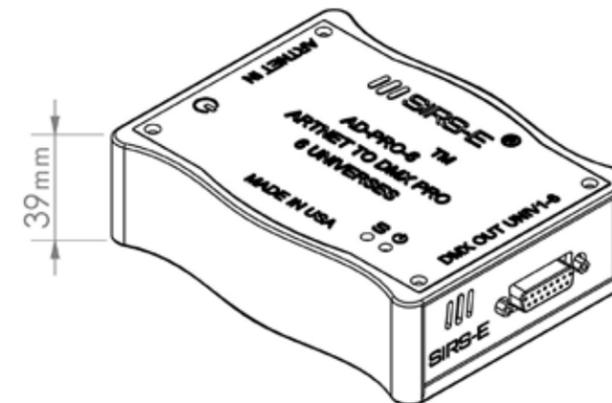
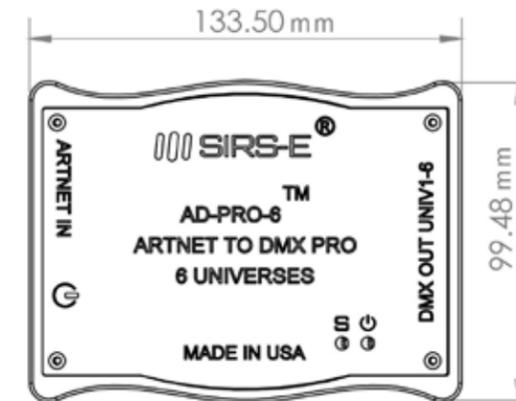

Tech Specs

Input: Ethernet ArtNet Protocol
Output: DMX 512 Protocol
Supply Current 350mA
Input Supply Voltage: 7V-24V



Shine Club, McAllen, TX



RGBW 4-in-1

With the 4-in-1 RGBW LED Strip, you no longer have to sacrifice half your diodes to get both RGB and White light.

By combining both RGB and white in one diode, you now have absolute control over color selection. Create unique colors such as pastels, which are virtually impossible with any other strip.

The RGBW 4-in-1 strips are available in Neutral White, Warm White and Amber, and each one allows you to experiment with color in unique and creative ways to perfectly achieve your desired look.



4 in 1 LED Strip RGBW



Product Details

- UL Class 2 Listed- E479339
- 12V cuttable every 3 LEDs
- 24V cuttable every 6 LEDs
- 4 colors in every LED
- RGB+Amber, Neutral White or Warm White
- Fully dimmable & DMX addressable
- Over 4 billion color combinations
- Can be put inside a recessed channel or extrusion
- UV & IR free

12V Tech Specs

- Double Density
- 72 LEDs/m
- 5050 LED Chip (5x5mm)
- 360 LEDs per reel
- 16.4ft / 5m reel
- Available in IP40 or IP68 ratings
- 12 V DC, 69.42 W, 5562 lm (WW)
- 12 V DC, 70.14 W, 6084 lm (WN)
- 12 V DC, 70.45 W, 5006 lm (A)

24V Tech Specs

- Double Density
- 72 LEDs/m
- 5050 LED Chip (5x5mm)
- 360 LEDs per reel
- 16.4ft / 5m reel
- Available in IP40 or IP68 ratings
- 24 V DC, 91.06 W, 6118 lm (WW)
- 24 V DC, 91.56 W, 6692 lm (WN)
- 24 V DC, 94.70 W, 5507 lm (A)

Ordering Guide

LED SIZE	DC VOLTAGE	COLOR	LEDs/m	IP
5050	XX	RGBXX	72	XX
	12	A		40
	24	WW		67
		WN		68

Color Temperatures

- A - Amber - N/A
- WW - Warm White - 3,000°K
- WN - Neutral White - 6,000°K

IP RATINGS

- IP40 - Non-waterproof
- IP67 - Waterproof
- IP68 - Submersible

Segment Close Up & Dimensions

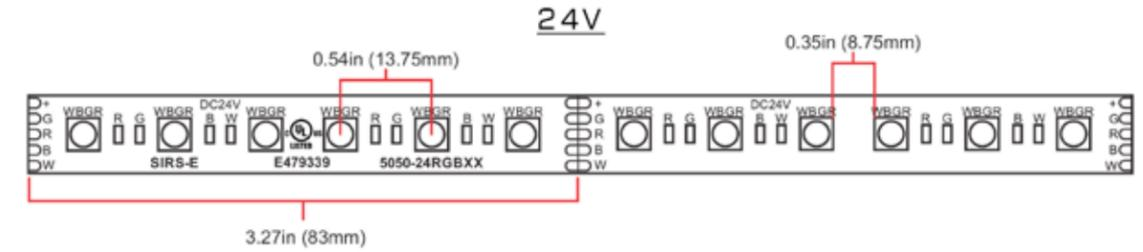
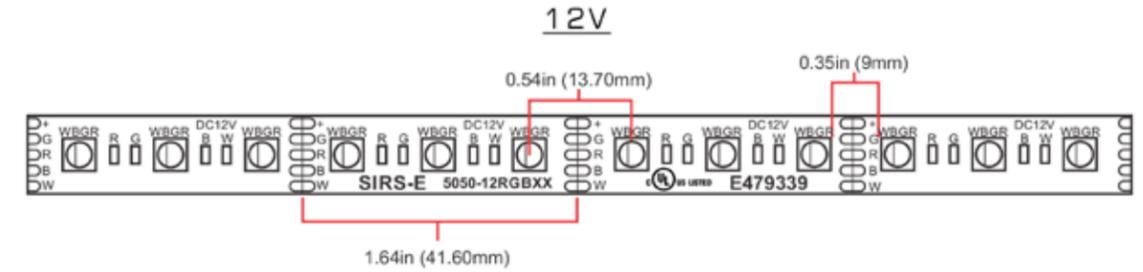

Front View

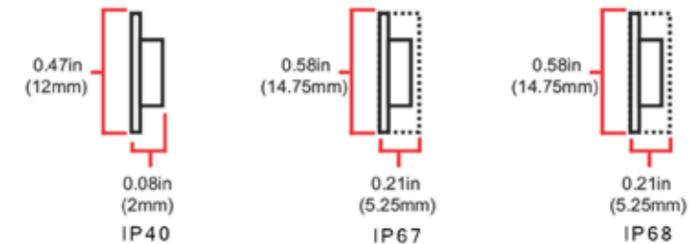

Dusit Thani Guam Resort

RGB

The High Quality LED RGB Strip line is perfect for creating rich, vivid colors. From just three colors, red, green and blue, you can create millions of combinations suitable for a wide range of applications such as store displays, home accent lighting and even live stage events.

Both single density and double density strips are available depending on your project's specific needs, as well as IP67 & IP68 versions perfect for outdoor use or submerged lighting displays.





Single Density LED Strip

RGB

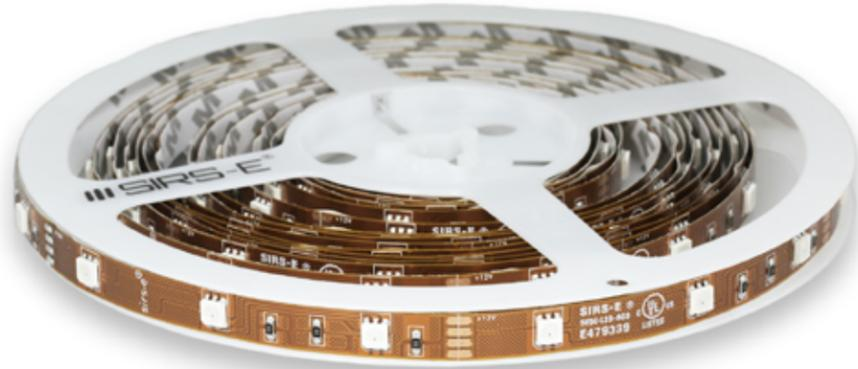

Product Details

UL Class 2 Listed- E479339
 12V cuttable every 3 LEDs
 24V cuttable every 5 LEDs
 Fully dimmable & DMX addressable
 Over 16 million color combinations
 Can be put inside a recessed channel or extrusion
 402 lm/m, 123 lm/ft
 UV & IR free

12V Tech Specs

Single Density
 30 LEDs/m
 5050 LED Chip (5x5mm)
 150 LEDs per reel
 16.4ft / 5m reel
 12 V DC, 29.26 W, 2010 lm
 Available in IP40, IP67 or IP68 ratings

24V Tech Specs

Single Density
 30 LEDs/m
 5050 LED Chip (5x5mm)
 150 LEDs per reel
 16.4ft / 5m reel
 24 V DC, 39.48 W, 2211 lm
 Available in IP40, IP67 or IP68 ratings

Ordering Guide

LED SIZE	DC VOLTAGE	COLOR	LEDs/m	IP
5050	XX	RGB	30	XX
	12			40
	24			67
				68

IP RATINGS

IP40 - Non-waterproof
 IP67 - Waterproof
 IP68 - Submersible

Segment Close Up & Dimensions

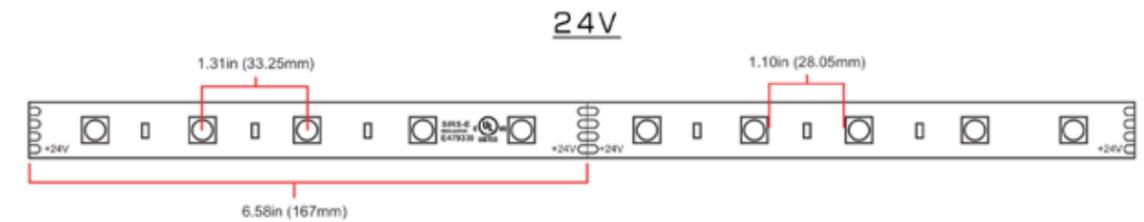
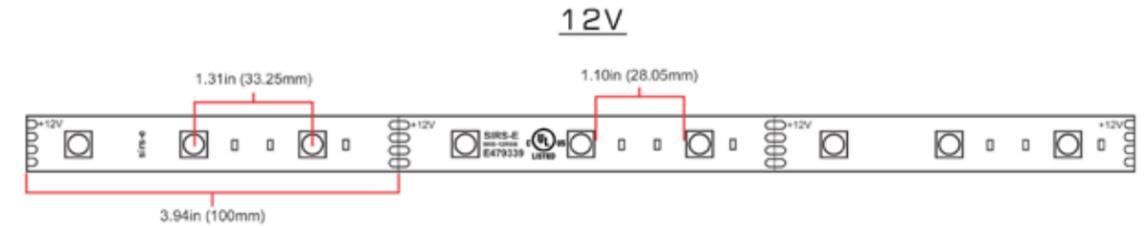

Front View

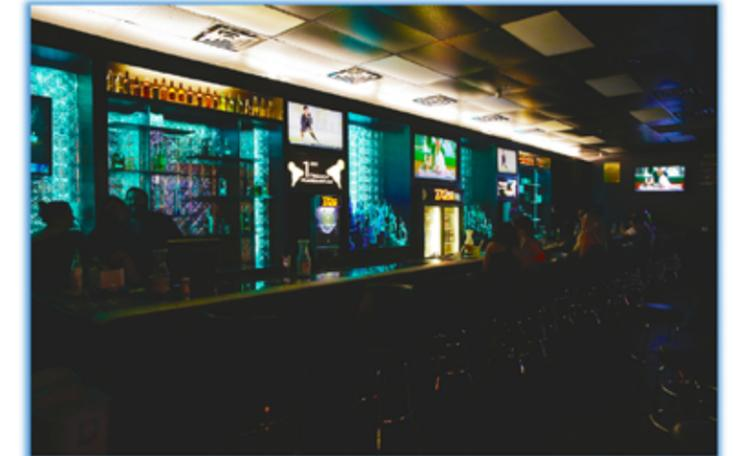
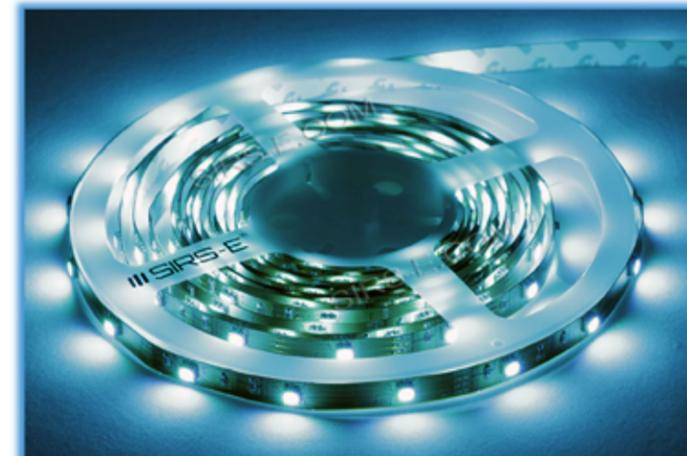
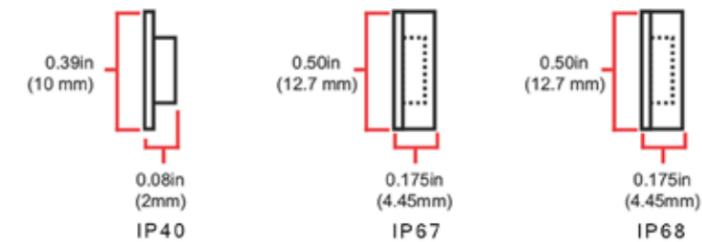

Cigar Bar, McAllen TX



Double Density LED Strip

RGB



Product Details

- UL Class 2 Listed- E479339
- 12V Cuttable every 3 LEDs
- 24V Cuttable every 6 LEDs
- Fully dimmable & DMX addressable
- Over 16 million color combinations
- Can be put inside a recessed channel or extrusion
- UV & IR free

12V Tech Specs

- Double Density
- 60 LEDs/m
- 5050 LED Chip (5x5mm)
- 300 LEDs per reel
- 16.4ft / 5m reel
- 12 V DC, 51.56 W, 4020 lm
- Available in IP40, IP67 or IP68 ratings

24V Tech Specs

- Double Density
- 60 LEDs/m
- 5050 LED Chip (5x5mm)
- 300 LEDs per reel
- 16.4ft / 5m reel
- 24 V DC, 65.81 W, 4422 lm
- Available in IP40, IP67 or IP68 ratings

Ordering Guide

LED SIZE	DC VOLTAGE	COLOR	LEDs/m	IP
5050	XX	RGB	60	XX
	12			40
	24			67
				68

IP RATINGS

- IP40 - Non-waterproof
- IP67 - Waterproof
- IP68 - Submersible

Segment Close Up & Dimensions

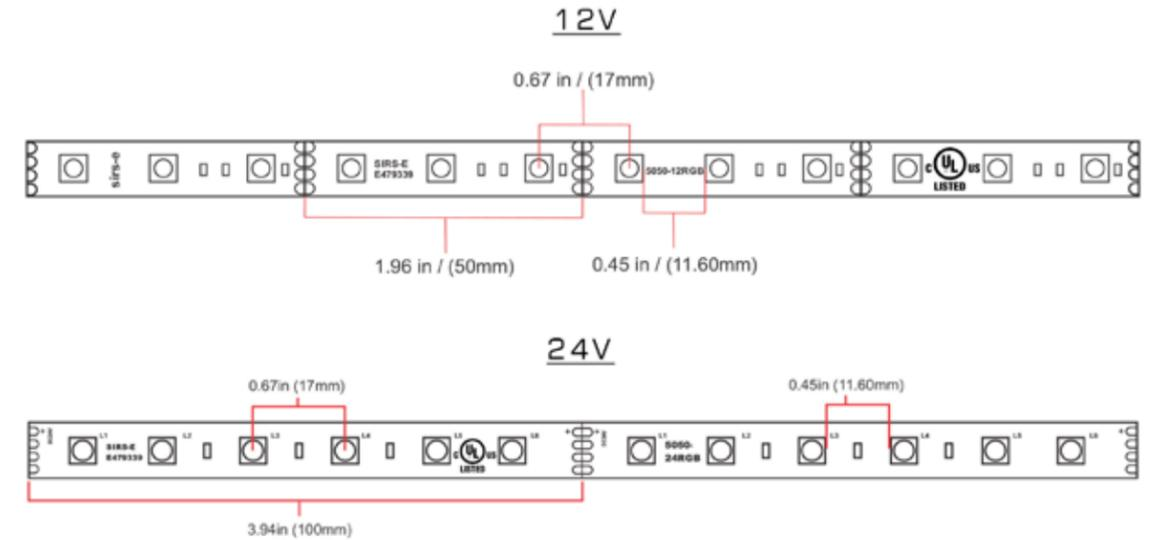

Front View

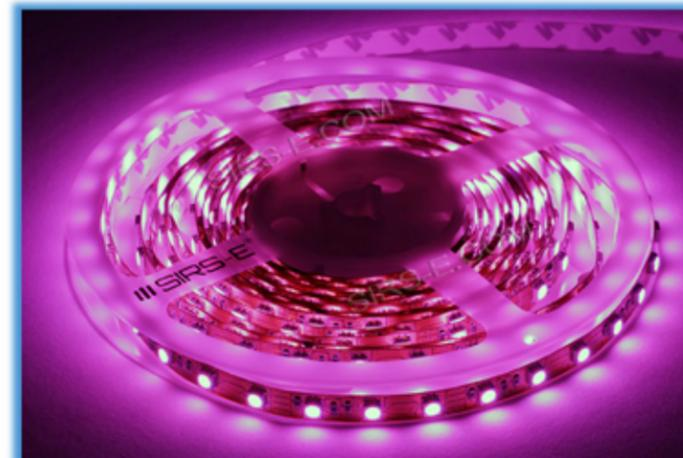
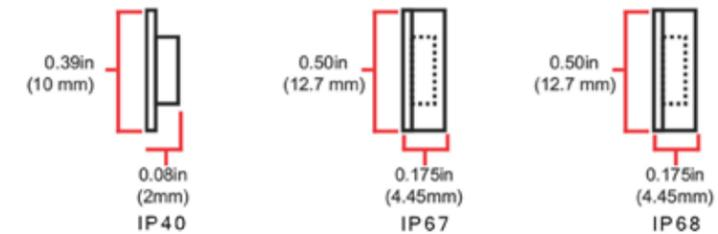

Cigar Bar, McAllen TX

White

White LED strips are ideal for creating the perfect ambience for both residential and commercial locations. Use them for cabinets, furniture, advertisements or landscapes to create the perfect mood. These strips are available in three different variations of white to match the feel of your project.

Neutral white has a color temperature range of approximately 6000K, which will give you a color resembling clear daylight. Warm white ranges around 3000K and evokes a soft and welcoming atmosphere. Cool white ranges in the area of 9000K and is perfect for creating an ultra-modern look that draws the eye.





Single Density LED Strip

WHITE



Product Details

- UL Class 2 Listed- E479339
- 12V Cuttable every 3 LEDs
- 24V Cuttable every 5 LEDs
- Fully dimmable & DMX addressable
- Available in Neutral, Cool & Warm
- Can be put inside a recessed channel or extrusion
- UV & IR free

12V Tech Specs

- Single Density
- 30 LEDs/m
- 5050 LED Chip (5x5mm)
- 150 LEDs per reel
- 16.4ft / 5m reel
- Available in IP40, IP67 or IP68 ratings
- 12 V DC, 30.24 W, 3812 lm (WN)
- 12 V DC, 34.80 W, 4462 lm (WW)
- 12 V DC, 28.56 W, 2874 lm (WC)

24V Tech Specs

- Single Density
- 30 LEDs/m
- 5050 LED Chip (5x5mm)
- 150 LEDs per reel
- 16.4ft / 5m reel
- Available in IP40, IP67 or IP68 ratings
- 24 V DC, 42.36 W, 4193 lm (WN)
- 24 V DC, 42.05 W, 4908 lm (WW)
- 24 V DC, 40.68 W, 3161 lm (WC)

Ordering Guide

LED SIZE	DC VOLTAGE	COLOR	LEDs/m	IP
5050	XX	W	30	XX
	12	N	40	
	24	W	67	
		C	68	

Color Temperatures

- WW - Warm White - 3,000°K
- WN - Neutral White - 6,000°K
- WC - Cool White - 6,000°K

IP RATINGS

- IP40 - Non-waterproof
- IP67 - Waterproof
- IP68 - Submersible

Segment Close Up & Dimensions

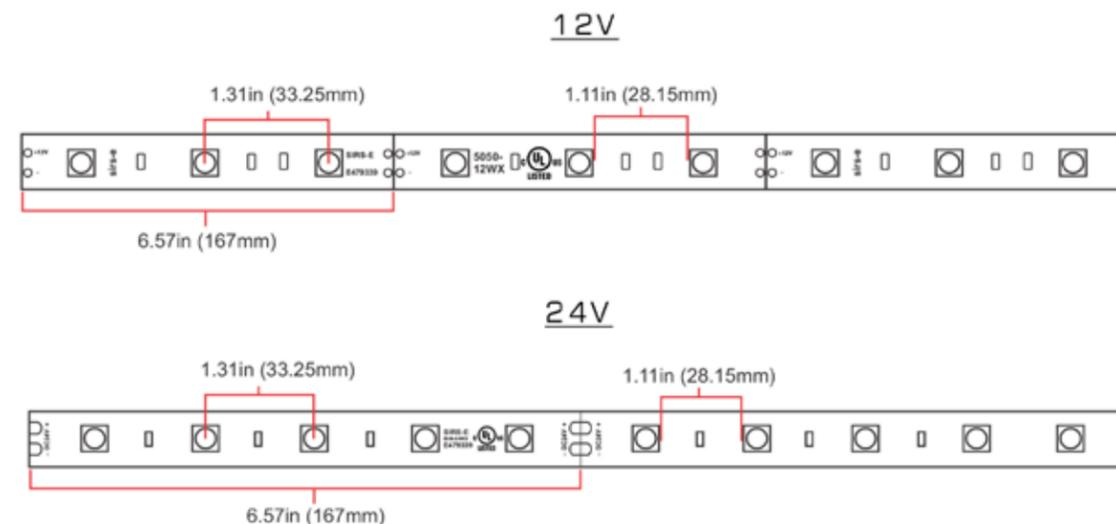

Front View

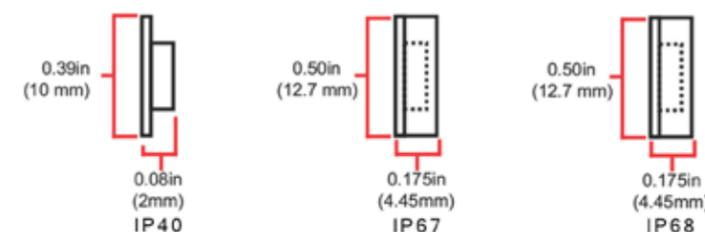

Dusit Thani Guam Resort



Double Density LED Strip

WHITE



Product Details

- UL Class 2 Listed- E479339
- 12V Cuttable every 3 LEDs
- 24V Cuttable every 6 LEDs
- Fully dimmable & DMX addressable
- Available in Neutral, Cool & Warm
- Can be put inside a recessed channel or extrusion
- UV & IR free

12V Tech Specs

- Double Density
- 60 LEDs/m
- 5050 LED Chip (5x5mm)
- 300 LEDs per reel
- 16.4ft / 5m reel
- Available in IP40, IP67 or IP68 ratings
- 12 V DC, 57.72 W, 7622 lm (WN)
- 12 V DC, 56.40 W, 8923 lm (WW)
- 12 V DC, 52.08 W, 5749 lm (WC)

24V Tech Specs

- Double Density
- 60 LEDs/m
- 5050 LED Chip (5x5mm)
- 300 LEDs per reel
- 16.4ft / 5m reel
- Available in IP40, IP67 or IP68 ratings
- 24 V DC, 72.43 W, 8384 lm (WN)
- 24 V DC, 71.69 W, 9815 lm (WW)
- 24 V DC, 66.43 W, 6324 lm (WC)

Ordering Guide

LED SIZE	DC VOLTAGE	COLOR	LEDs/m	IP
5050	XX	W	60	XX
	12	N	40	
	24	W	67	
		C	68	

Color Temperatures

- WW - Warm White - 3,000°K
- WN - Neutral White - 6,000°K
- WC - Cool White - 9,000°K

IP RATINGS

- IP40 - Non-waterproof
- IP67 - Waterproof
- IP68 - Submersible

Segment Close Up & Dimensions

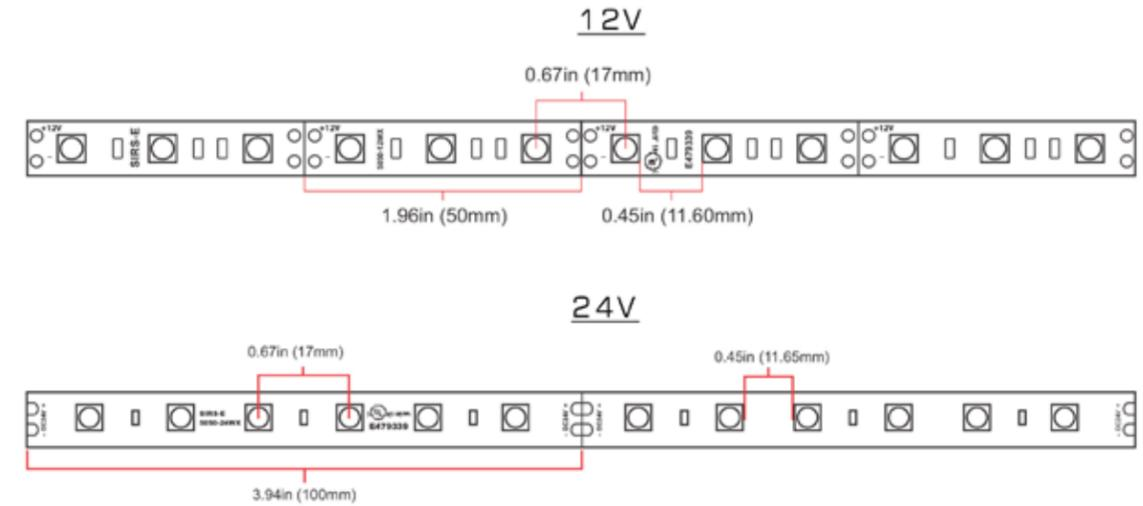

Front View

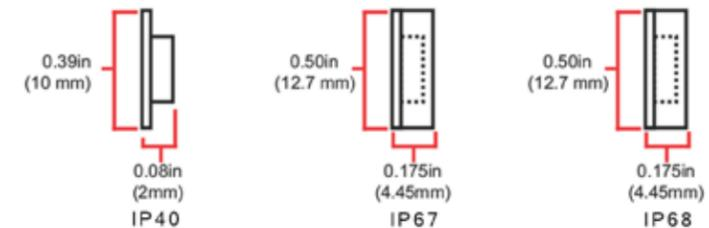

La Chismosa, Dominican Republic



LED Fluorescent Retrofit Kit

Product Details

- UL Listed Class 2 Kit
- LED strip - E479339
- Meanwell Power Supply - E334687
- Last 5-7X longer than fluorescents
- Low energy usage
- Simple plug & play installation
- Contains no UV rays or mercury



Tech Specs

- Double Density 60 LEDs/m
- 5050 LED Chip (5x5mm)
- Strip Power Consumption: 3.52W/ft
- Input: 120V AC 60Hz
- Output: 12V DC, 5.503A
- Power: 66.04 Watts
- Total Luminous Flux: 4728.3 lumens
- Neutral White color temp: 6176K

Wiring Diagram



LED Fluorescent Retrofit Kit

Get rid of your old inefficient fluorescent tubes and upgrade to the new LED Fluorescent Retrofit Kit. This kit comes with everything you need to go from box to installation in minutes.

Fluorescent lamps are marred with problems that range from annoying to dangerous. They are a big drain on your electric bill and emit heat, causing your AC to work around the clock. Flickering, discoloration, black spotting and UV rays all add to the potential health risks.

LED lighting eliminates all these problems. You can expect lower energy bills, reduced maintenance, crisper lighting that is easier on the eyes and much more. And for added peace of mind, all the components that make up this kit are UL Listed Class 2.

Light Output (Lumens)	4728
Watts	66.04
Lumens per Watt (Efficacy)	71.59
Color Accuracy Color Rendering Index (CRI)	84
Light Color Correlated Color Temperature (CCT)	6176 (Daylight)

Visit www.lightingfacts.com for the Label Reference Guide.





LED DMX Controllers

Our DMX-CON series is a line of LED DMX controllers that allow you to take the digital signals from your DMX console and converts them into analog signals. These signals can then be read by our RGB & RGBW strips, giving you an affordable solution for precise control over your lighting designs

The DMX-CON series is perfect for video applications due its flicker-free performance. Control anywhere from 3 to 6 channels of LED strips, LED modules and other types of 12-24V LED lighting fixtures depending on the model. Each channel can control up to 256 levels of intensity, giving you millions of color possibilities to explore.



RGB LED DMX Controller DMX-CON3-C2



Product Details

- UL Class 2 Listed- E479339
- Meets DMX512/1990
- 256 levels of brightness
- Can achieve asynchronous color change effects
- Capable of controlling LED light with 1-3 colors
- Freely set the DMX address 1-512

UL Tech Specs

- DMX512-A Digital Signal Protocol
- 512 addressable DMX Channels
- 3 output channels
- Max 100W
- Input: DC 12-24V
- Frequency: 5.2kHz Refresh Rate
- Class 2 circuit, isolated DMX input

Non-UL Tech Specs

- DMX512-A Digital Signal Protocol
- 512 addressable DMX Channels
- 3 output channels
- Max 216W
- Input: DC 12-24V
- Frequency: 5.2kHz Refresh Rate

Ordering Guide

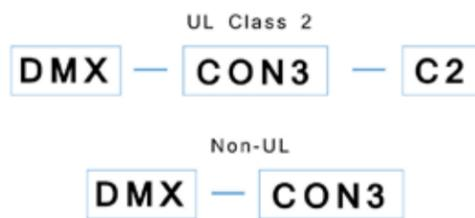

Dusit Thani Guam Resort

Dimensions

UL Class 2

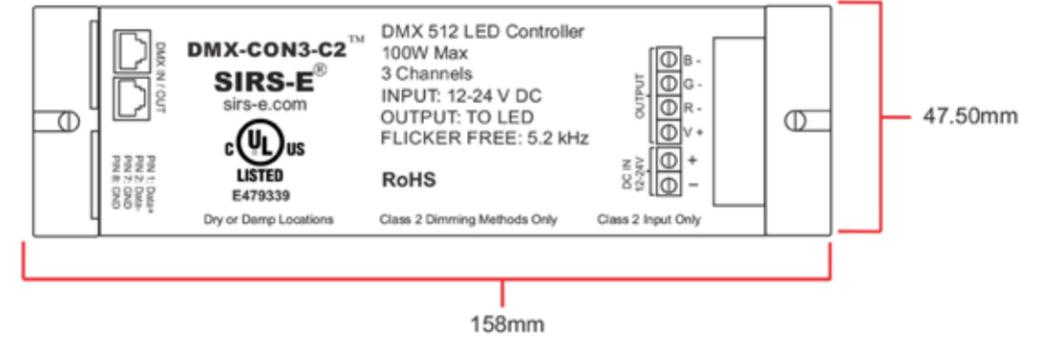

Non-UL

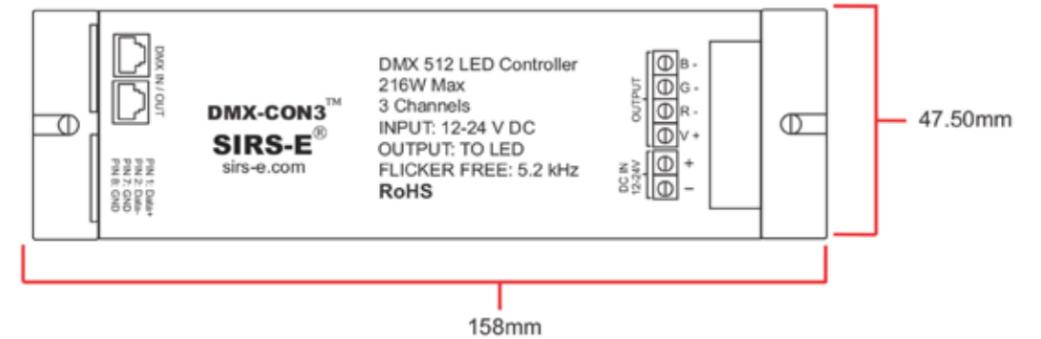

Front View



Addressing Samples



DMX Pinout

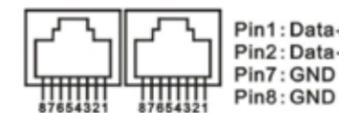

DIP Switch Value Chart

DIP	1	2	3	4	5	6	7	8	9
Value	1	2	4	8	16	32	64	128	256



RGBW LED DMX Controller DMX-CON4-C2

Product Details

- UL Class 2 Listed- E479339
- Meets DMX512/1990
- 256 levels of brightness
- Can achieve asynchronous color change effects
- Capable of controlling LED light with 1-4 colors
- Freely set the DMX address 1-512



UL Tech Specs

- DMX512-A Digital Signal Protocol
- 512 addressable DMX Channels
- 4 output channels
- Max 100W
- Input: DC 12-24V
- Frequency: 5.2kHz Refresh Rate
- Class 2 circuit, isolated DMX input

Non-UL Tech Specs

- DMX512-A Digital Signal Protocol
- 512 addressable DMX Channels
- 4 output channels
- Max 240W
- Input: DC 12-24V
- Frequency: 5.2kHz Refresh Rate

Ordering Guide

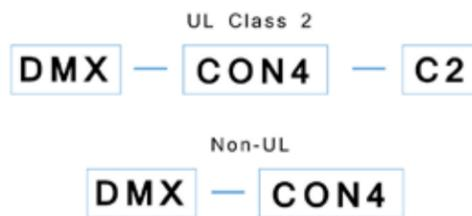

Dusit Thani Guam Resort

Dimensions

UL Class 2

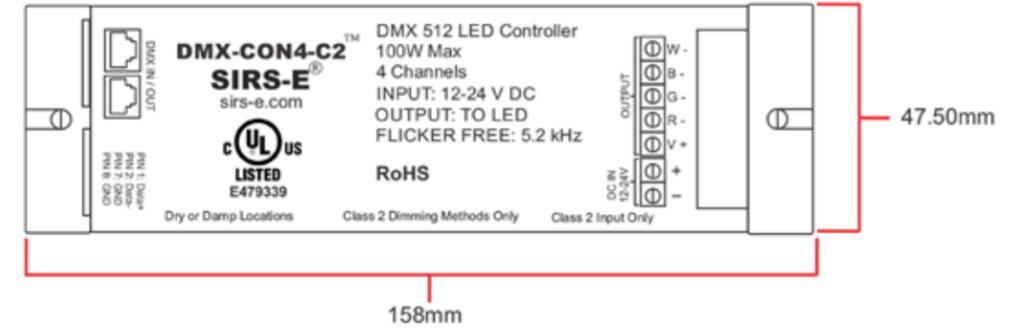

Non-UL

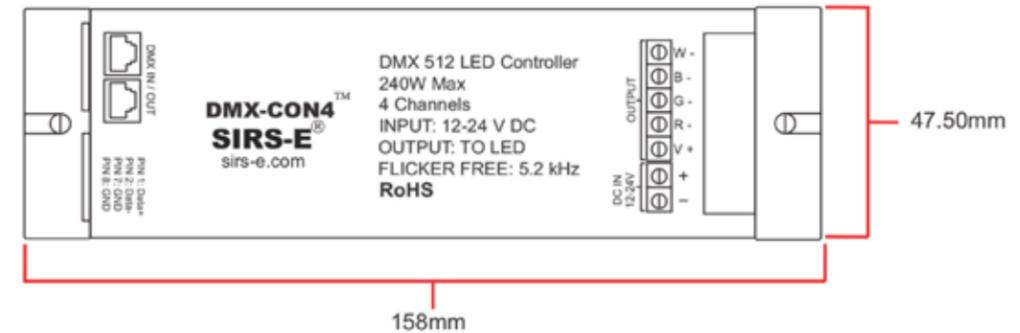

Front View



Addressing Samples



DMX Pinout

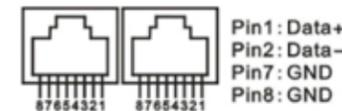

DIP Switch Value Chart

DIP	1	2	3	4	5	6	7	8	9
Value	1	2	4	8	16	32	64	128	256

RGBW LED DMX Controller
DMX-CON4V2

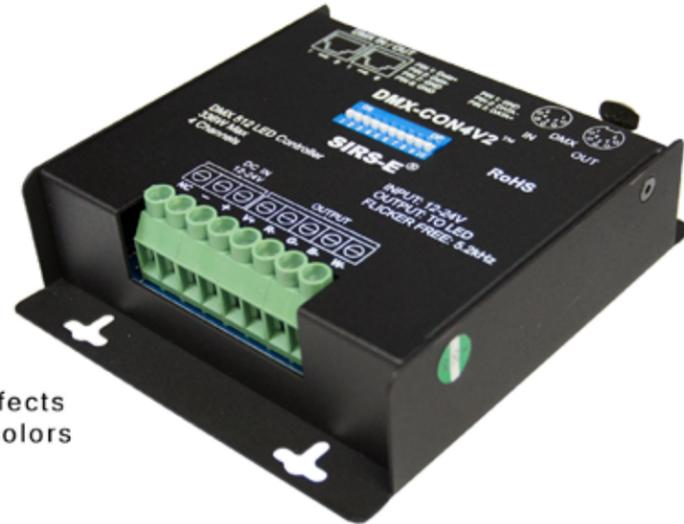

Product Details

- Meets DMX512/1990 protocol
- 256 levels of brightness
- Can achieve asynchronous color change effects
- Capable of controlling LED light with 1-4 colors
- Freely set the DMX address 1-512
- RJ45 and 5-Pin XLR DMX Input/Output

Tech Specs

- DMX512-A Digital Signal Protocol
- 512 addressable DMX Channels
- 4 output channels
- Max 336W total power
- Input: DC 12-24V
- Frequency: 5.2kHz Refresh Rate

Dimensions

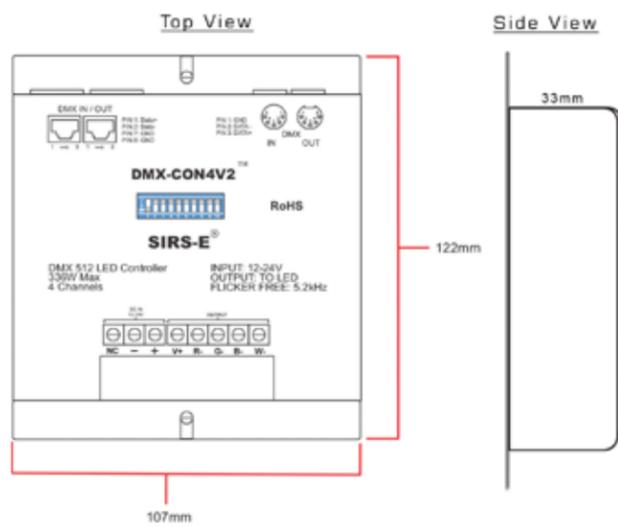

Multi LED DMX Controller
DMX-CON6



Product Details

- Meets DMX512/1990
- 256 levels of brightness
- Can achieve asynchronous color change effects
- Capable of controlling LED light with 1-6 colors
- Freely set the DMX address 1-512

Tech Specs

- DMX512-A Digital Signal Protocol
- 512 addressable DMX Channels
- 6 output channels
- Max 432W total power
- Input: DC 12-24V
- Frequency: 5.2kHz Refresh Rate

Dimensions

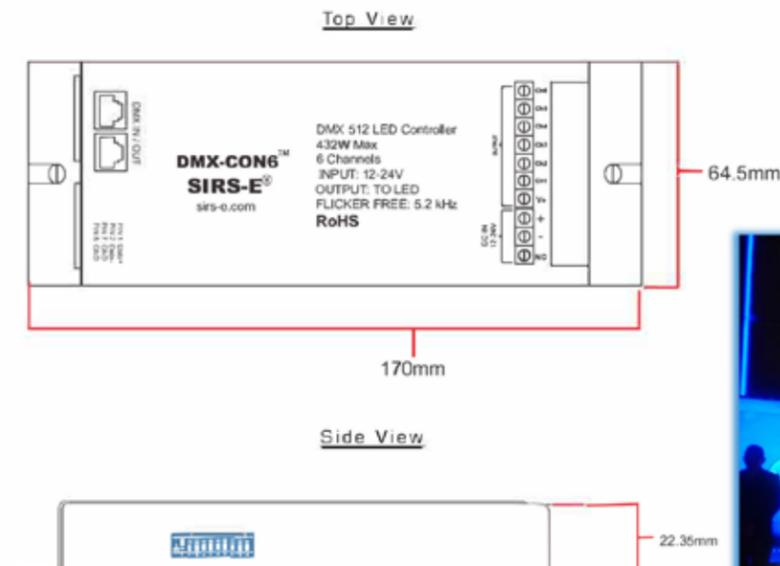

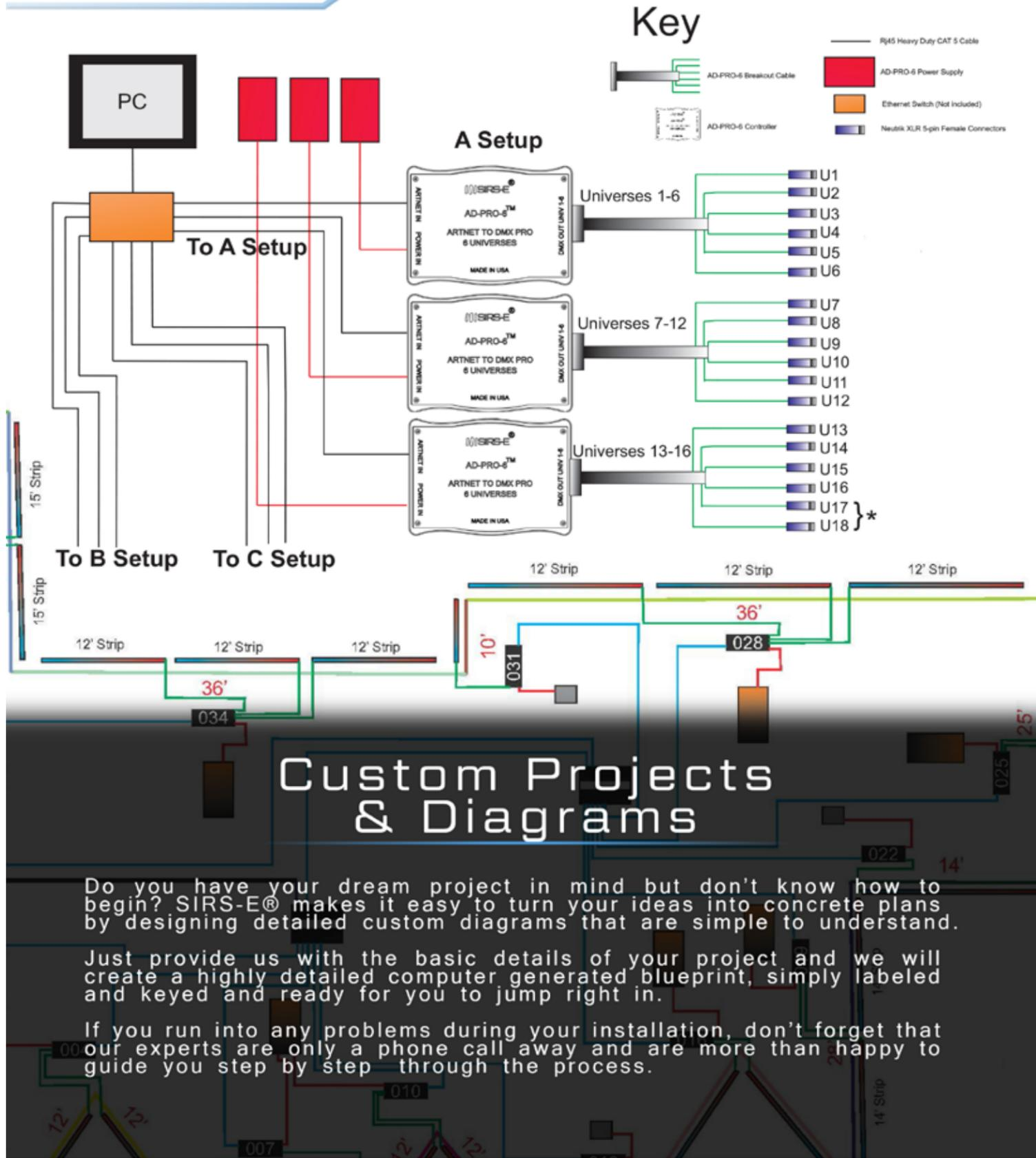

Custom Projects & Diagrams

Do you have your dream project in mind but don't know how to begin? SIRS-E® makes it easy to turn your ideas into concrete plans by designing detailed custom diagrams that are simple to understand.

Just provide us with the basic details of your project and we will create a highly detailed computer generated blueprint, simply labeled and keyed and ready for you to jump right in.

If you run into any problems during your installation, don't forget that our experts are only a phone call away and are more than happy to guide you step by step through the process.

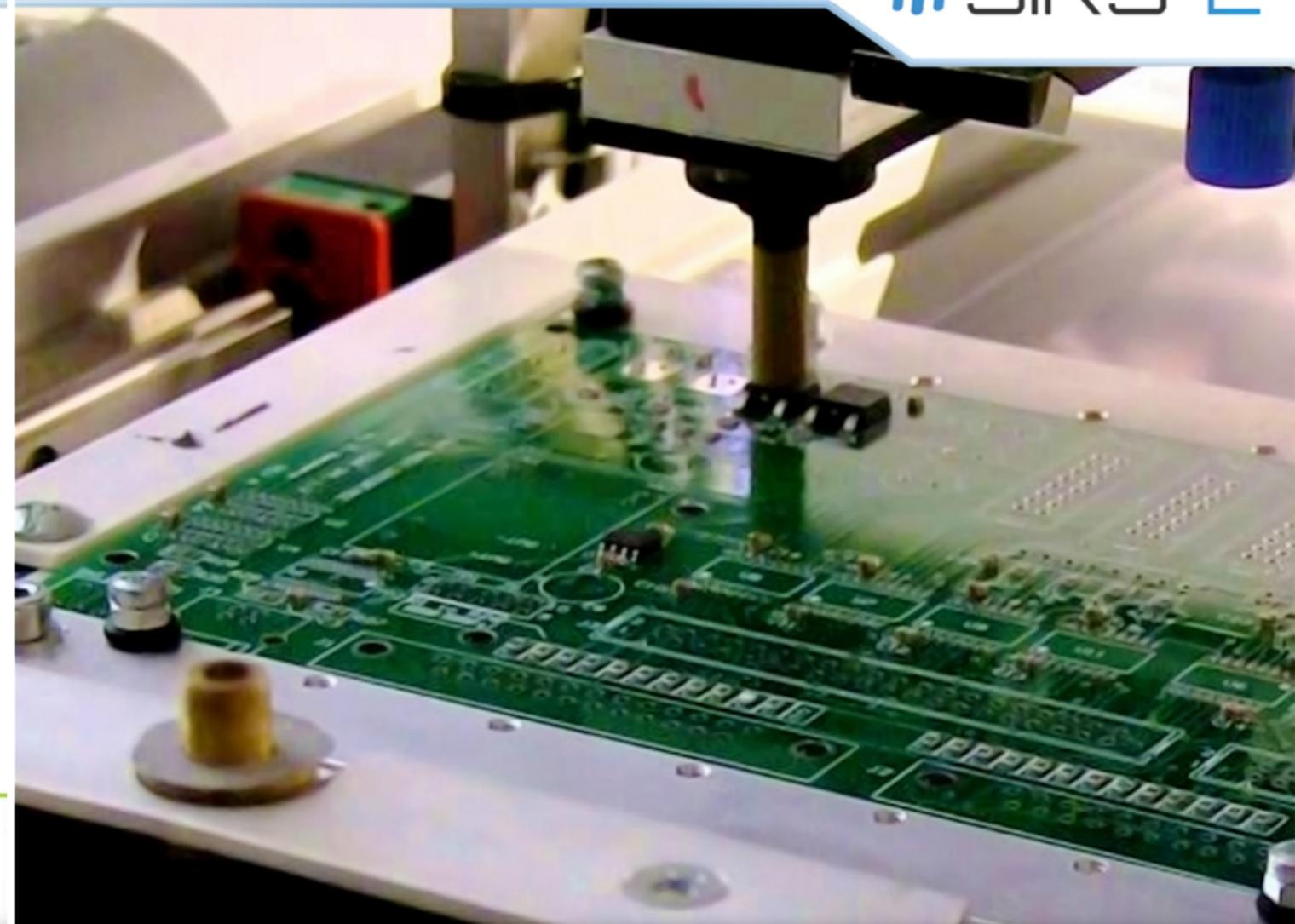

Manufacturing & OEM Services

SIRS-E® is proud to offer US manufacturing solutions for the LED lighting industry with a core focus in LED strip luminaires and controllers. Our in-house facilities allow us to specialize in the design, mechanical implementation, and production involved in the manufacturing process.

Our main clientele and services are involved with uses of LED strip (tape) lighting and controls for architectural installations of residential and commercial applications, hospitality industries, stage and studio designs, production industry, and the Hotel/Resort industry.

We also offer customizations and OEM services which can utilize our internal resources to produce new product designs and/or rebranding options of our current product lines. We are more than happy to work with your engineers or provide full engineering solutions for resellers.



Enhance Your Space with LED Lighting

Do you want to enhance the lighting in your home or business? Have you thought about adding accent lighting in your cupboards, bookshelves, display cases, or even your patio?

Our white LED strips can help you accomplish all of that. We have them available in warm white, neutral white, cool white, and for those outdoor lighting projects, we have waterproof versions available. These strips can be used in almost any application you can think of and best of all, they are easy to install.

White LED 5050 Strip

- Warm White (3000K)
- Neutral White (6000K)
- Cool White (9000K)
- High luminescence efficiency and low power consumption
- Easy Installation, 3M self adhesive back side
- Matched joint connector and direct soldering
- The flexible LED strip can be divided into 50mm (approx. 2 inches) segments!
- 3 year limited warranty



Visit us at sirs-e.com

/// SIRS-E®



Thank you for going through our 2016 Product Guide.
Please feel free to contact us about your next project and
we will be glad to help get you on the right track.

SIRS-E®, INC.
6101 N 23rd St. Ste K
McAllen, TX 78504
956.522.2006
www.sirs-e.com
contactus@sirs-e.com